



An **AEP** Company

---

BOUNDLESS ENERGY<sup>SM</sup>

**Ohio Choice Operations**

**CRES Provider Handbook**

**May 2022**

---

## Contents

Chapter 1 - Introduction .....	1
1.1 Purpose of Handbook .....	1
1.2 Disclaimer.....	1
Chapter 2 - Overview .....	2
2.1 Introduction .....	2
2.2 Overview of Program .....	2
2.3 Definitions.....	3
2.4 Contact Information/Resources.....	4
Chapter 3 – CRES Provider/Power Broker PUCO Certification and AEP Ohio Registration .....	5
3.1 PUCO Certification .....	5
3.2 AEP Ohio Registration .....	5
3.3 EDI Certification Testing.....	5
3.4 AEP Ohio’s Response to Applications .....	6
3.5 Responsibilities of Parties .....	6
3.6 Changes to CRES Provider or Power Broker Registration .....	8
Chapter 4 – Business Partner Portal (BPP).....	9
4.1 Access.....	9
4.2 Pre-Enrollment Customer List.....	10
4.3 Enroll From Your Wallet (EFYW) .....	10
4.4 Usage History .....	10
4.5 Rate Ready Codes .....	11
Chapter 5 – Electronic Data Exchange.....	13
5.1 Electronic Data Interchange (EDI).....	13
5.2 EDI Transmission Requirements .....	13
5.3 EDI Implementation Guidelines .....	13
5.4 Hardware and Software Requirements .....	14
5.5 Data Formats.....	14
5.6 Transaction Processing .....	14
Chapter 6 – Customer Enrollment .....	15
6.1 Customer Information .....	15
6.2 Service Delivery Identifier Number.....	15

---

6.3	Enrollment and Switches .....	17
6.4	Effective Start and End Dates.....	18
6.5	Synchronization (Sync) List .....	19
6.6	Usage History Request .....	19
6.7	Meter Information Requests .....	20
6.8	Rate Schedules and Rate Structures .....	20
6.9	Terms and Conditions .....	20
6.10	Customer Account Maintenance .....	21
6.11	Customer’s Right to Rescind .....	21
Chapter 7 – Business Processes .....		23
7.1	Drops.....	23
7.2	Auto-Cancel Functionality.....	24
7.3	Financial Responsibility End Date (FRED).....	24
7.4	Entity Changes.....	25
7.5	Peak Load Contribution Tags .....	25
7.6	PJM Billing Line Item Transfers .....	26
7.7	Unaccounted for Energy (UFE).....	26
Chapter 8 – Billing.....		28
8.1	Bill Methods.....	28
8.2	Dual Billing .....	28
8.3	AEP Ohio Consolidated Bill Ready.....	29
8.4	AEP Ohio Consolidated Rate-Ready.....	31
8.5	Change Requests.....	32
8.6	Write-Offs .....	32
8.7	Payment Agreements.....	35
8.8	Payment Processing .....	36
8.9	Bill Due Dates .....	36
8.10	CRES Provider Dispute Resolution .....	37
8.11	Dispute Resolution Procedure .....	37
8.12	AEP Ohio Leveled Payment Options .....	37
8.13	Disconnection of Service for Non-Payment.....	38
8.14	Billing for AEP Ohio Services .....	38

---

8.15	Billing Agent Registration.....	38
8.16	Bill Messages on AEP Ohio Bill .....	39
8.17	Bill Formats .....	39
Chapter 9 – Metering.....		45
9.1	Meter Service Provider (MSP) Registration .....	45
9.2	Guidelines for Meter Installation.....	45
9.3	Meter Ownership Options .....	45
9.4	Meter Testing and Maintenance .....	46
9.5	Meter Calibrations .....	46
9.6	Meter Costs.....	46
9.7	Meter Investigation Orders.....	46
9.8	Standard Meter Specifications.....	46
9.9	Combination Meter Specifications .....	47
9.10	Time of Use Meter Specifications .....	47
9.11	Interval Metering Specifications .....	47
9.12	Abnormal Conditions .....	48
Chapter 10 – Meter Data Management .....		49
10.1	Meter Data Management Agent Registration .....	49
10.2	Meter Reading Schedules .....	49
10.3	Policy for Estimating Usage.....	49
10.4	Telemeter Reading Options .....	51
10.5	Meter Data Retrieval.....	52
10.6	Providing Meter Data.....	52
10.7	Abnormal Conditions .....	52
Chapter 11- Transmission and Related Services.....		53
11.1	PJM Agreements .....	53

---

# Chapter 1 - Introduction

## 1.1 Purpose of Handbook

The AEP Ohio Choice Operations CRES Provider/Power Broker Handbook, herein after will be referenced as the Handbook, has been developed to communicate critical information regarding participation in the Ohio Customer Choice Program of Ohio Power Company, d/b/a AEP Ohio. AEP Ohio includes both rate jurisdictions: Columbus Southern Power and Ohio Power.

## 1.2 Disclaimer

Every attempt has been made to ensure accuracy and consistency in the information provided in this Handbook. However, if you believe there are inaccuracies or inconsistencies, please contact AEP Ohio at [ohiochoiceoperation@aep.com](mailto:ohiochoiceoperation@aep.com).

AEP OHIO IS NOT LIABLE FOR ANY DIRECT, INDIRECT, INCIDENTAL, CONSEQUENTIAL, SPECIAL, EXEMPLARY, PUNITIVE, OR OTHER DAMAGES ARISING OUT OF, OR RELATING IN ANY WAY TO, THE USE OF THIS HANDBOOK.

This Handbook does not constitute legal, technical or financial advice from AEP Ohio. Any party intending to participate in the Ohio Customer Choice Program should seek independent legal, technical and financial advice. All legal relationships between any party doing business with AEP Ohio shall be controlled by the applicable laws, regulations and tariffs, and by the respective agreements signed between those parties and AEP Ohio, and not by the provisions of this handbook.

## Chapter 2 - Overview

### 2.1 Introduction

The Handbook has been developed to communicate critical information regarding participation in the AEP Ohio Customer Choice Program.

As a Competitive Retail Electric Service (CRES) Provider, this Handbook will help you:

- Understand how to become certified with the Public Utilities Commission of Ohio (PUCO) and registered as a CRES Provider with AEP Ohio.
- Enroll customers
- Schedule and deliver energy in AEP Ohio's service territory
- Understand the resolution process if disputes with AEP Ohio would occur
- Understand the procedures for Electronic Data Interchange (EDI)
- Clarify load profiling and the settlement process

### 2.2 Overview of Program

The success of customer choice is dependent upon both customer and CRES Provider participation. AEP Ohio is committed to establishing a collaborative and cooperative working relationship with interested and qualified CRES Providers.

All entities desiring to sell retail generation services are subject to certain standards to ensure adequate consumer protection and a level playing field for all CRES Providers.

For applicable legislation, visit

<https://puco.ohio.gov/wps/portal/gov/puco/utilities/electricity/resources/competitive-retail-electric-service-certification> . PUCO case numbers and Ohio Administrative Code references are listed below:

- Competitive Retail Electric Service Providers (Chapter 4901:1-21, 4901:1-24, 4901:1-27, 4901:1-28, and 4901:1-29 of the Ohio Administrative Code)
- Minimum Competitive Retail Electric Service Standards (case number 99-1611-EL-ORD)

CRES Providers/Power Brokers and Aggregators must apply for and be granted a certificate to operate by the PUCO. CRES Providers/Power Brokers who wish to participate in the AEP Ohio Customer Choice Program will need to meet all requirements outlined in Chapter 3 of this document. These are also found on our website at: <https://aepohio.com/account/service/choice/cres/Register.aspx>.

## 2.3 Definitions

**BPP**, Business Partner Portal – AEP Ohio’s dedicated portal where registered CRES Providers and Power Brokers can access customer data and meter attributes.

**CRES**, Competitive Retail Electric Service Provider – Companies interested in providing competitive retail generation services in AEP Ohio service territory. (Also known as a Power Marketer or Supplier.)

**EDI**, Electronic Data Interchange – A standardized method for formatting and electronically exchanging data between trading partners.

**EDC/EDU**, Electric Distribution Company/Electric Distribution Utility – The utility, AEP Ohio.

**HU**, Historical Usage – A customer’s historical consumption data.

**IDR**, Interval Data Recorder - A meter that collects customer usage in kWh and kW demand in time stamped interval periods.

**LOA**, Letter of Authorization – A standardized AEP Ohio specific form that is required to be signed by the customer to release historical usage.

**PUCO**, Public Utilities Commission of Ohio.

**SDI**, Service Delivery Identifier – 17-digit number used to enroll a customer in AEP Ohio’s territory. It can be found on the customer’s bill. This is not the AEP Ohio account number.

**TLA**, Three Letter Acronym - These make communications shorter.

## **2.4 Contact Information/Resources**

### **AEP Ohio**

For CRES Provider assistance, email any inquiries to [ohiochoiceoperation@aep.com](mailto:ohiochoiceoperation@aep.com). Ohio Choice Operation staff will usually respond within three business days.

Mailing Address: AEP Ohio  
Ohio Choice Operations  
700 Morrison Road  
Gahanna, OH 43230

Business Hours: Monday – Friday 8:00 a.m. – 5:00 p.m. EPT, excluding AEP Ohio holidays

Website: <https://www.aepohio.com/company/about/choice/>

### **Public Utilities Commission of Ohio**

Phone: 614-466-3292 or toll free at 1-800-686-7826

Mailing Address: 180 E. Broad Street, Columbus, OH 43215-3793

Website: [www.puco.ohio.gov/](http://www.puco.ohio.gov/)

### **Apples to Apples Comparison**

<http://energychoice.ohio.gov>



## **Chapter 3 – CRES Provider/Power Broker PUCO Certification and AEP Ohio Registration**

### **3.1 PUCO Certification**

PUCO certification is a prerequisite for CRES Provider registration with AEP Ohio. PUCO certification requirements can be found at:

<https://puco.ohio.gov/wps/portal/gov/puco/utilities/electricity/resources/competitive-retail-electric-service-certification>

### **3.2 AEP Ohio Registration**

To register for the first time, or an annual renewal as a Competitive Retail Electric Service Provider (CRES) or Power Broker in AEP Ohio's Customer Choice Program, the required documents to be completed are found on our website.

CRES Provider: <https://www.aepohio.com/company/about/choice/cres/provider>

Power Broker: <https://www.aepohio.com/company/about/choice/cres/power-broker>

The completed required documents are to be emailed to [cresregistration@aep.com](mailto:cresregistration@aep.com) for registration review and processing. An invoice for the registration fee will soon follow by email.

### **3.3 EDI Certification Testing**

All CRES Providers submitting for initial registration in AEP Ohio are required to participate in EDI Certification Flight Testing (not a requirement for Power Brokers).

More information can be found at:

<https://www.aepohio.com/company/about/choice/cres/edi-testing-certification>.

The EDI testing schedule associated with initial CRES provider registration is published annually and posted at <https://www.aepohio.com/company/about/choice/cres/edi-test-schedules>.

### **3.4 AEP Ohio's Response to Applications**

Upon receipt of an application, AEP Ohio will determine if the application is complete. If incomplete, the applicant will be notified within 10 calendar days of the information still needed, as noted in [AEP Ohio Supplier Term and Conditions](#). The applicant will be notified of the result of its creditworthiness evaluation and advised if any financial instrument for security will be required. Once any necessary financial instrument is provided to AEP Ohio, the Electronic Data Interchange (EDI) certification is completed, PUCO certification is obtained, all appropriate agreements are executed, and all other required documents are completed, a CRES Provider will be registered to operate in AEP Ohio's service territory.

### **3.5 Responsibilities of Parties**

In keeping with rules approved by the PUCO, which are outlined in the Ohio Administrative Code Chapter 4901:1-10 and 4901:1-21, responsibilities of the parties with respect to Customer Choice include, but are not limited to, the items listed below.

CRES Providers/Power Brokers will:

- Obtain customer authorization using the AEP Ohio Letter of Authorization (LOA) for enrollment and release of historical usage information. This LOA can be found at: <https://www.aepohio.com/company/about/choice/cres/metering-usage>
- Exchange information electronically with AEP Ohio for enrollment, discontinuance of service, etc. Not a requirement for Power Brokers.
- Provide a bill to the customer for competitive energy service when a dual bill option is used. Not a requirement for Power Brokers.

- Provide the necessary billing information when an AEP Ohio consolidated (single) customer billing is provided. Not a requirement for Power Brokers.
- Provide a point of contact to facilitate business and technical communications.
- Abide by applicable rules issued by the PUCO and maintain certification with the PUCO.
- Implement and maintain EDI transmission guidelines as referenced within this document as well as those issued by the PUCO via the Ohio Electronic Data Interchange Working Group (OEWG). Not a requirement for Power Brokers.
- Attempt to resolve customer disputes related to CRES Provider charges or issues. Not a requirement for Power Brokers.
- If applicable, collect taxes and distribute the information to the appropriate taxing authority.

AEP Ohio will:

- Upon request, provide customers with a list of certified CRES providers registered with AEP Ohio. This list can also be found at: <http://energychoice.ohio.gov>  
<https://www.aepohio.com/company/about/choice/residential/providers>
- Provide customer information to CRES providers as permitted by PUCO rules and with customer's permission by use of an AEP Ohio Letter of Authorization.
- Exchange information electronically with CRES providers for enrollment, changes or discontinuance of service, etc.
- Maintain customer choice information on company website.
- Provide appropriate load profiles to CRES providers.
- Provide the customer with a bill for distribution and transmission charges when a dual bill option is used.
- Provide the customer a bill including the CRES Provider's charges as specified in tariffs when AEP Ohio consolidated customer billing is provided by AEP Ohio.
- Maintain records on customer payments and fees as per the billing services provided.
- Provide the CRES Provider with a point of contact to facilitate business and technical communications.

- Abide by applicable rules issued by the PUCO.
- Implement and maintain EDI transmission guidelines as referenced within this document as well as those issued by the PUCO via the Ohio Electronic Data Interchange Working Group (OEWG).
- Provide meter reading and usage information to the appropriate service provider when AEP Ohio is responsible for reading the customer's meter(s).
- Attempt to resolve customer or CRES Provider disputes related to AEP Ohio charges or service.
- Forward payments from customers, as received, to the CRES providers according to the contractual agreement with the CRES Provider. This applies when AEP Ohio is providing consolidated billing.
- AEP collects and pays any applicable taxes on its own behalf.

### **3.6 Changes to CRES Provider or Power Broker Registration**

CRES Providers and Power Brokers are required to notify AEP Ohio of any material change to registration-related information within 21 days of becoming aware of such facts. These changes include legal and trade name changes, acquisitions, assignments, bankruptcy, EDI vendor changes, changes to contact information, banking information, PJM information and other similar events. All such changes must be communicated to [cresregistration@aep.com](mailto:cresregistration@aep.com). Our team will respond with any requirements necessary to complete the requested change.

## Chapter 4 – Business Partner Portal (BPP)

### 4.1 Access

AEP Ohio has a dedicated site called Business Partner Portal (BPP) where registered CRES Providers/Power Brokers can access AEP Ohio's pre-enrollment customer list, their customer sync list, their customer payment arrangements list, add LOAs, obtain customer's usage data, obtain customer's meter attributes, and input rate codes for Rate Ready billing. Additionally, the Business Partner Portal (BPP) houses the Enroll from Your Wallet program, more information can be found in section 4.3.

An email request must be sent to [ohiochoiceoperation@aep.com](mailto:ohiochoiceoperation@aep.com) to receive login information for BOLT which allows users access to BPP. BOLT is the web based registration system used to request access to BPP. Each CRES Provider/Power Broker will need to select a person from their company to be a CRES Broker, that person will be able to register and maintain their company users within the site. The CRES Broker has the ability to add or revoke access to BPP for individuals in their organization with the role of "CRES User." The CRES Broker will receive an email with User ID and login instructions for BOLT and BPP applications.

AEP Ohio uses IForgot, a self-serve password online application, to access Business Partner Portal. Users must setup an account, complete security questions, and maintain password updates for continued access to BPP. Passwords expire every 90-days. It is recommended that User IDs be individual email addresses as group addresses may cause access issues.

These platforms and instructions are located at:

<https://www.aepohio.com/company/about/choice/cres/business-portal>

## **4.2 Pre-Enrollment Customer List**

AEP Ohio's pre-enrollment customer list can be downloaded at any time free of charge from Business Partner Portal (BPP), which is available to all CRES Providers/Power Brokers who are certified by the PUCO and registered with AEP Ohio.

The Pre-enrollment Customer List is updated the first calendar day of each month. Only active accounts will appear on this list. If a customer has more than one Service Delivery Point (multiple tariffs), there will be a separate record for each. Each will have a unique SDI.

If the account is a non-metered account, such as outdoor lighting, load profiles can be found on our website at: <https://www.aepohio.com/company/about/choice/cres/load-profiles>.

## **4.3 Enroll From Your Wallet (EFYW)**

This program is housed in BPP; it allows CRES Providers to obtain a customer's SDI for the purpose of usage download and enrollment. Enroll From Your Wallet requires the phone number assigned to the customer account, and either the last four digits of the account holders social security number or the amount from one of the last three bills. The CRES Provider must have potential customers sign an AEP Ohio Letter of Authorization (LOA), as required by Rule 4901:1-10-24 section (E), and keep it on file for one year. AEP Ohio conducts periodic audits of the participating CRES Providers in this program and request the LOA based on random selecton. CRES Provider must forward the AEP Ohio LOA within two business days of the request. The PUCO will receive audit results. To participate in this program AEP Ohio requires a completed Enroll From Your Wallet (EFYW) agreement and a one-time non-refundable payment of \$5,000.00.

## **4.4 Usage History**

Twenty-four billing months (if available) of usage history for interval data, provided the account has an AMI meter, may be downloaded free of charge from Business Partner Portal (BPP) by registered CRES Providers/Power Brokers. Cumulative data remains at 12 months (if available). Access to account interval data requires a completed and customer signed AEP Ohio LOA to be uploaded on the INTERVAL DATA LETTER OF AUTHORIZATION ENTRY page, located on BPP, under USAGE DATA/REPORTS, under the drop down menu of Add LOA. Usage history (interval or cumulative) may also be requested via EDI. The party seeking the customer information certifies that it is entitled to such information pursuant to applicable law and has obtained the consent of the customer to acquire such information from AEP Ohio. AEP Ohio reserves the right, at any time, to audit the CRES Provider's/Power Broker's documentation of customer's consent (i.e., the AEP Ohio Letter of Authorization signed by the customer dated on or before the EDI request or BPP download).

For those requestors who do not meet the criteria above and/or who request cumulative or interval data via email to [ohiochoiceoperation@aep.com](mailto:ohiochoiceoperation@aep.com), a signed Letter of Authorization (LOA) from the customer must be attached to the email request.

The LOAs provided on our website at

<https://aepohio.com/account/service/choice/cres/meteringusage.aspx> are the only LOA forms that will be accepted by AEP Ohio. For interval data, there is a \$50 fee per SDI due to the manual process. The email request must include the SDI number, the customer account name and an acknowledgement that the requestor agrees to pay the fee associated with obtaining this data. This data will be provided in an Excel spreadsheet and emailed to the requestor.

All usage data presented is billed data and could be up to 30 days old. Downloaded data will be in CSV format. If a blank file is returned upon downloading from BPP, the possibilities are that no interval data exists, the size/metering of the account restricts the interval download, or the account is in Opt Out status.

#### **4.5 Rate Ready Codes**

AEP Ohio offers Rate Ready billing as a billing option. CRES Providers who are registered for Consolidated Rate Ready will manage their Rate Ready rates in Business Partner Portal (BPP). CRES Providers must complete CRES Provider registration (see Chapter 3) before CRES Providers can utilize AEP Ohio's BPP for entering rate codes.

For instructions on entering rates, please see Rate Ready FAQs found at:

<https://aepohio.com/account/service/choice/cres/rateready.aspx>. There is no limit to the number of rate codes entered. One rate code at a time may be entered, submitted, and approved. It is important to note that once a rate is entered and approved in BPP by a CRES user, it cannot be modified or edited. It is the CRES Provider's responsibility to change their customer to the appropriate rate. Changing a Rate Ready customer's rate code will require an 814C (change request). Please see Section 8.5 for timing of 814Cs.



## **Chapter 5 – Electronic Data Exchange**

### **5.1 Electronic Data Interchange (EDI)**

Electronic Data Interchange (EDI) is an internationally recognized standard for formatting and exchanging information between the CRES Provider and AEP Ohio. The exchange and translation of data is handled behind the scenes by the EDI team at AEP's Clearinghouse. The EDI Vendors are CRES Provider's point of contact for ensuring EDI transactions are handled correctly.

### **5.2 EDI Transmission Requirements**

AEP Ohio has established standards that ensure a consistent platform for all CRES Providers to access the same data. AEP Ohio requires that CRES Providers comply with standard conditions for service which include, but are not limited to:

- Compliance with mutually derived EDI requirements found in the EDC/CRES Agreement for sending and receiving the data required for processing, where any exceptions to EDI standards will be provided.
- Use of Electronic Business Transactions (EBT) and EDI for sending and receiving data.
- Participation in all EDI tests needed to enable a successful connectivity and market implementation.

Please see Chapter 3 of this document for AEP Ohio's CRES registration process.

### **5.3 EDI Implementation Guidelines**

EDI standards can be accessed at:

<https://puco.ohio.gov/wps/portal/gov/puco/utilities/electricity/resources/electronic-data-interchange>

In addition, the requirements detailed in the EDC/CRES Agreement will dictate how AEP Ohio and the CRES Provider will conduct electronic business.

## **5.4 Hardware and Software Requirements**

EDI transport will be provided by mutually agreed mechanisms between AEP Ohio and the CRES Provider that are consistent with Ohio guidelines for electronic data transfer. As specified by Ohio guidelines, the default transport mechanism will be via North America Energy Standards Board (NAESB) unless both parties agree otherwise.

## **5.5 Data Formats**

No special grouping or packaging is required except that transmissions must be compatible with ANSI x12 enveloping standards. The sender should be aware that individual transactions will be processed in the order in which they occur within functional group envelopes.

## **5.6 Transaction Processing**

- EDI transactions must be received by 5:00 p.m. EPT to be considered received on that business day.
- Normal work hours: 6:30 a.m. – 9:30 p.m. EPT Monday through Friday and 9:00 a.m. – 9:00 p.m. EPT on Saturdays.
- Holiday schedules will be posted annually at:

<https://www.aepohio.com/account/service/choice/cres/MeterReadingSchedule.aspx>

## Chapter 6 – Customer Enrollment

### 6.1 Customer Information

A customer’s authorization is required to release any account data prior to enrollment with the CRES Provider or prior to the completed registration with AEP Ohio. A registered CRES Provider can submit an 814HU (historic usage) request via EDI, as outlined in Section 4.3 of this document. The party seeking the customer information certifies that it is entitled to such information pursuant to applicable law and has obtained the consent of the customer to acquire such information from AEP Ohio. AEP Ohio reserves the right to request documentation of customer’s consent (i.e., Letter of Authorization signed by the customer).

### 6.2 Service Delivery Identifier Number

The Service Delivery Identification Number (SDI) will be used in lieu of a customer account number for all EDI transactions in AEP Ohio. The SDI will be used in all interactions between AEP Ohio and the CRES Provider.

The SDI is a 17-character number with the following format:

Character Position	Data Definition
1 – 2 (2 characters)	State compliant data
3 – 7 (5 characters)	AEP Ohio rate jurisdiction D.O.E. number
8 – 9 (2 characters)	AEP Ohio rate jurisdiction code
10 – 17 (8 characters)	Randomly generated number within the company partition

State Code	DOE Number	Operating Co.	Random Number
Ohio 00	*CSP 04062	10	XXXXXXXXXX
Ohio 00	*OP 14006	07	XXXXXXXXXX
*The AEP Ohio rate jurisdiction codes: Columbus Southern Power is 10, sample 000406210XXXXXXXXX Ohio Power Company is 07, sample 001400607XXXXXXXXX			

The CRES Provider will be responsible for sending an EDI 814E (enrollment request) transaction to AEP Ohio, and AEP Ohio will respond with an acknowledgement

message. The AEP Ohio switch notification letter sent to the customer will always reference the SDI number.

The SDI number is assigned first to a specific premise (physical location), and second at the tariff level. The relationship of the SDI to the customer account number is a “many to one” relationship. It is possible that multiple SDIs belong to one customer account number. SDIs associated with the same premise and customer may be billed on one monthly statement when the bill is presented by AEP Ohio.

The EDI 814E must contain the appropriate DUNS number for the SDI. For example, if the 814E is for an Ohio Power SDI but the transaction contains a Columbus Southern Power DUNS number, the 814E will be rejected by our system with reason code “Account Not Found.” The DUNS numbers for both AEP Ohio rate jurisdictions are shown below:

<b>Rate Jurisdiction</b>	<b>DUNS #</b>
Ohio Power	002899953
Columbus Southern Power	007901739

The customer can select a different provider for each SDI. The SDI number will always stay with the premise. The SDI does not stay with the customer after moving to another location. Currently, AEP Ohio does not offer seamless move or instant connect.

Below are some illustrative examples of multiple SDIs:

- A premise where there is a meter and a non-metered load, such as an outdoor light, would have two SDIs since each of these is billed on a different tariff.
- If there are two or more meters at a premise, each would have its own SDI number.
- If there are two meters and each is billed on a separate tariff, such as in the case of a residence, outdoor lighting, separate garage, or barn, there would be separate SDIs for each point.
- If there is a meter and three different types and sizes of outdoor lights at a premise, there would be four SDIs because each type and size of light would be billed under a separate tariff. If this same account had multiple numbers of lights such as two 175-

watt mercury vapor lights, three 100-watt high pressure sodium lights, and one 400-watt high pressure sodium floodlight, there would be four SDIs. The quantity of outdoor lights does not matter as the tariff is based on the size and type. Therefore, both 175-watt mercury vapor lights would be covered by one SDI and so forth.

### 6.3 Enrollment and Switches

All enrollments/switches must be received at least 12 calendar days prior to the next scheduled meter reading date.

The effective time of the switch is midnight EPT on the scheduled meter reading date. This means the new supplier will begin scheduling supply the day after the meter reading date for hour one.

Postdated or predated enrollments and switches will not be accepted.

Enrollments/switches not received at least 12 calendar days prior to the next meter reading will not become effective until the following month’s meter reading date. EDI transactions must be received by 5:00 p.m. EPT to be considered received on that business day.

Below is an illustrative example of how to count the 12 days:

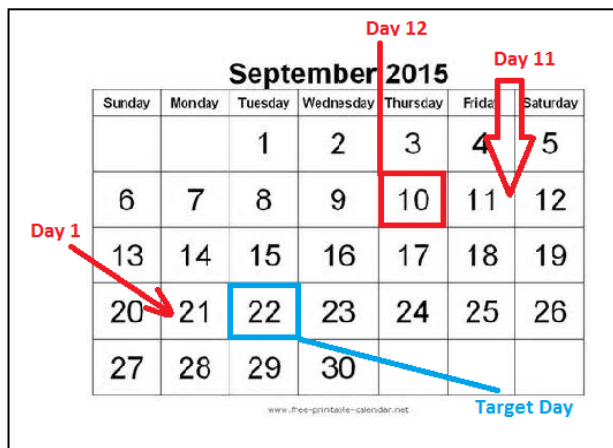

Target day is September 22nd (intended switch date).

Don't count Target Day, begin counting 12 days backward.

September 10<sup>th</sup> is the LAST day to attempt to make Target Day switch.

AEP Ohio will accept the first valid switch request for an account for an effective date aligned with the 12 day rule. If a switch is rejected because it was not the first received (Not First In), then the CRES Provider must resubmit the switch request to become effective at the next available meter reading date.

Customers may switch no more than once per month to a new CRES Provider. A fee of \$5.00 will be assessed for every switch, if applicable, per SDI. AEP Ohio will bill the fee to the CRES Provider.

However, AEP Ohio's switch fee is waived:

- The first time a customer switches to a CRES Provider.
- If a customer is switched involuntarily.
- If a customer switches to or from a government aggregation group.
- If a customer's former provider's services have been permanently terminated.

#### **6.4 Effective Start and End Dates**

AEP uses dates within the meter reading pending window for the liability start/end dates when the meter is not read on the scheduled read date. This could range from one work day prior to the scheduled read date through two workdays after the scheduled read date.

When the start or end liability dates are changed due to a customer transaction or read cycle change, 814Cs will be generated to inform CRES Providers of the change in start/end dates. DTM 150 and DTM 151 will be the loops that indicate start date and/or end date changes.

Further information on the DTM loop can be found in the EDI Guidelines which are published on the PUCO website at <http://www.puco.ohio.gov/puco/index.cfm/industry-information/industry-topics/ohio-edi-working-group/>.

<b>Segment:</b>	<b>DTM</b> Date/Time Reference (Effective Date)
<b>Position:</b>	040
<b>Loop:</b>	LIN Optional
<b>Level:</b>	Detail
<b>Usage:</b>	Optional
<b>Max Use:</b>	>1
<b>Purpose:</b>	To specify pertinent dates and times
<b>Syntax Notes:</b>	<ol style="list-style-type: none"> <li>1 At least one of <b>DTM02</b> <b>DTM03</b> or <b>DTM05</b> is required.</li> <li>2 If <b>DTM04</b> is present, then <b>DTM03</b> is required.</li> <li>3 If either <b>DTM05</b> or <b>DTM06</b> is present, then the other is required.</li> </ol>
<b>Semantic Notes:</b>	
<b>Comments:</b>	
<b>Notes:</b>	Request: Required on EDU Initiated Request, Not Used on CRES Initiated Request Response: Required on EDU Initiated Response, Not Used on CRES Initiated Response <b>DTM~152~19990115</b>

Please see Section 7.3 for further information on the Financial Responsibility End Date.

### 6.5 Synchronization (Sync) List

A list of all accounts on the CRES Provider’s supply can be downloaded from Business Partner Portal (BPP) on the BPP Reports page at their convenience. This report is generally used for reconciliation purposes and is updated nightly.

### 6.6 Usage History Request

A maximum of 12 months of cumulative data and/or 24 months of interval data history, if available, may be downloaded free of charge from the Business Partner Portal by CRES Providers and Power Brokers who are certified by the PUCO and registered with AEP Ohio. Usage history may also be requested via EDI. With both methods, the party seeking the customer information certifies that it is entitled to such information pursuant to applicable law and has obtained the consent of the customer to acquire such information from AEP Ohio. AEP Ohio reserves the right, at any time, to request the CRES Provider’s/Power Broker’s documentation of customer’s consent (i.e., the AEP Ohio Letter of Authorization signed by the customer dated on or before the EDI request or BPP download). The LOAs provided on our website at <https://aepohio.com/account/service/choice/cres/meteringusage.aspx> are the only LOA forms that will be accepted by AEP Ohio.

Historical usage can be requested before or after enrollment using an EDI 814HU (historical usage) request transaction. The HU request should not be included in the enrollment request transaction as a second Line Item Identification (LIN) loop. The 814E (enrollment) and the 814HU requests should be sent in separate 814 transactions to AEP Ohio. Data will be returned in an 867HU transaction.

Actual customer data available for both cumulative/interval data may be less than 12 or 24 months respectively. All data presented is billed data and could be up to 30 days old. Downloaded data will be in .csv format. If a blank file is returned upon download, no interval data exists or the account is in Opt Out status.

## **6.7 Meter Information Requests**

Refer to Ohio EDI Working Group (OEWG) found at

<http://www.puco.ohio.gov/puco/index.cfm/industry-information/industry-topics/ohio-edi-working-group/>.

## **6.8 Rate Schedules and Rate Structures**

Rate schedules and bill calculation tools are available at

<https://www.aepohio.com/account/service/choice/cres/Tariffs.aspx>.

## **6.9 Terms and Conditions**

Terms and Conditions of Service are available on the PUCO website at:

<http://www.puco.ohio.gov/apps/directorylister/index.cfm?path=Electric%5COhio%20Power%2C%20OHIO%20POWER%20COMPANY%5C&filearea=2>

Or at AEP Ohio.com:

<https://www.aepohio.com/account/bills/rates/AEPOhioRatesTariffsOH.aspx>.



## **6.10 Customer Account Maintenance**

The following procedures will be used for customer enrollments, switches, and changes to customer data. Several variations of the EDI 814 transactions are used for these scenarios:

- Customer enrolls for generation services.
- Customer cancels enrollment.
- Customer switches to new CRES Provider.
- Customer cancels CRES Provider switch.
- Customer or CRES Provider initiates drop.
- Customer contacts AEP Ohio to drop CRES Provider.

The following changes to a customer's account require information exchanges between AEP Ohio and the CRES Provider:

- Customer contacts AEP Ohio to relocate outside the company's service territory.
- Customer contacts AEP Ohio to relocate within the company's service territory.
- Customer data changes from AEP Ohio, such as tariff, cycle, or meter information.
- Customer contacts AEP Ohio to relocate outside the company's service territory – revert to owner account if tenant/landlord agreement in place.
- Customer contacts AEP Ohio to relocate within the company's service territory – revert to owner account if tenant/landlord agreement in place.

## **6.11 Customer's Right to Rescind**

In accordance with rules established by the PUCO, AEP Ohio will send the customer notification of a switch via U.S. Mail or email address if available. The letter will contain rescission instructions, and the customer has seven calendar days from date of the letter to object and cancel the switch. AEP Ohio must receive notification by 5:00 p.m. EPT on the date provided in the body of the letter. Should a customer object, AEP Ohio

will send the CRES Provider an EDI transaction notifying of drop prior to the effective date of the switch.

## Chapter 7 – Business Processes

### 7.1 Drops

Drops being submitted by CRES Providers (for their existing customers) must be received at AEP Ohio no later than 12 days prior to the next scheduled meter read date. Drops received later than 12 days will be accepted for the following month's scheduled read date.

If a CRES Provider wants to cancel a pending enrollment or pending drop, an 814D(Drop) or 814R(Reinstatement) must be submitted no later than two business days prior to the scheduled switch date in order to be accepted.

The following scenarios are provided as illustration based on actual questions we have received from CRES Providers:

#### Pending Enrollment

Q: We submitted an 814E which was accepted with a switch date of April 20. The customer asked us to cancel the enrollment. What do we need to do and is it too late?

A: Submit an 814D no later than two business days prior to the scheduled switch date.

#### Drop already-switched customer

Q: Our customer's contract ended so we want to submit an 814D. How many days in advance to drop an existing customer?

A: Submit 814D no later than 12 days prior to the next scheduled meter read date.

#### Reinstatement

Q: Our customer's contract ended so we submitted an 814D. The customer then signed another contract with us. How do we stop the drop?

A: Submit an 814R no later than two business days prior to the scheduled switch date.

## **7.2 Auto-Cancel Functionality**

When AEP Ohio performs a cancel/rebill, our system will automatically cancel the CRES Provider's original charge. The CRES Provider does not need to submit a cancel 810 transaction for Bill-Ready accounts; if one is submitted, it will be rejected. However, AEP Ohio does not automatically cancel supplier-initiated adjustments.

## **7.3 Financial Responsibility End Date (FRED)**

AEP Ohio established a Financial Responsibility End Date (FRED) to help reduce 810 transactions after the date in which CRES Provider charges are scheduled to be written off in our systems. FRED is in effect even if there are no charges to write-off. The date will be established for each account in which there is an established liability end date; FRED is one billing cycle from the liability end date. For further information regarding the write-off process, please see Section 8.6 of this document.

The FRED logic suppresses/rejects any 810 transaction after the scheduled write-off date. All incoming 810 transactions are rejected and no 810 transactions are calculated on Rate Ready accounts for periods prior to the scheduled write-off date. If AEP initiates a cancel/rebill for a period during a CRES Provider's liability prior to the scheduled write-off date, then an 867 usage transaction will be sent; however, providers will not have the ability to send an 810 invoice transaction. The purpose of the 867 transaction is to alert the CRES Provider in case the billed usage changes for a period that may need to be rebilled by the CRES Provider independently. Also, AEP will not automatically cancel any CRES Provider's pre-existing 810 submittals in these instances.

With this logic, AEP does not include negative transactions (chargebacks) on the 820 for adjustments done after the write-off/FRED for service periods prior to the expired liability.

## **7.4 Entity Changes**

If a commercial customer experiences an entity name change which involves a Tax ID change, the existing account will be closed and a new account will be opened with the new customer name. The new customer will be assigned a new AEP Ohio account number; however, the SDI number will not change as it remains with the premise. Closing the original account will cause a drop to go out to the CRES Provider. If the new customer wishes to enroll with the CRES Provider, the CRES Provider would need to submit a new 814E (enrollment request) using the same SDI number.

## **7.5 Peak Load Contribution Tags**

AEP Ohio aggregates customer capacity tag obligations by CRES and applies PJM required weather normalization factors to the CRES tag totals. As an Electric Distribution Utility (EDU) in PJM, AEP Ohio submits these totals to PJM for settlement. PJM is responsible for application of other scaling factors such as Forecast Pool Requirement and Zonal RPM Scaling, with the exception of the weather normalization factor.

AEP Ohio calculates Peak Load Contribution tags based upon the customer's metered share of the peak, per PJM Manual 19. These PLC tags are included in the Pre-Enrollment Customer List and available on the Business Partner Portal. The aggregate of these tags scaled with the weather normalization factor is submitted to PJM.

Please see AEP Ohio's Calculations Processes document found at <https://www.aepohio.com/account/service/choice/cres/CalculationsProcesses.aspx>.

## 7.6 PJM Billing Line Item Transfers

On June 1, 2015 AEP Ohio assumed responsibility for items determined to be cost-based transmission-related charges. (These had previously been the responsibility of CRES Providers.)

AEP Ohio is responsible for the following charges/credits for both shopping and non-shopping customers' load. All other PJM billing statement line items continue to be the responsibility of the CRES Provider.

<b>ID#</b>	<b>CHARGES</b>
1100	Network Integration Transmission Service
1108	Transmission Enhancement
1115	Transmission Enhancement Settlement (EL05-121-009)
1320	Transmission Owner Scheduling, System Control and Dispatch Service
1330	Reactive Supply and Voltage Control from Generation and Other Sources Service
1450	Load Reconciliation for Transmission Owner Scheduling, System Control and Dispatch Service
1930	Generation Deactivation
	<b>CREDITS</b>
2130	Firm Point-to-Point Transmission Service
2140	Non-Firm Point-to-Point Transmission Service

To facilitate PJM's billing of the transmission line items to AEP Ohio, all registered CRES Providers are required to approve associated Billing Line Item Transfers through PJM's online Billing Line Item Transfer Tool (BLIT) as updated periodically by AEP Ohio. The CRES Provider must contact PJM to obtain access to the BLIT Tool found on the PJM website.

## 7.7 Unaccounted for Energy (UFE)

AEP Ohio applies an Unaccounted for Energy ("UFE") factor to all AEP Ohio zonal loads prior to data submission to PJM for hourly energy reallocation (PJM Settlement B).

- Unaccounted for Energy (UFE) represents the hourly Megawatt (“MW”) variance between the Company's total retail hourly energy (system load) and the hourly customer loads (both interval metered and profiled) with associated electrical losses.
- UFE is applied proportionally based upon the ratio of each Certified Supplier's load to the total load of the Certified Suppliers and the Company SSO load.
- A common UFE factor is used for both Columbus Southern Power and Ohio Power Company loads.
- UFE is applied to the 60-day true-up hourly energy settlement loads.
- AEP Ohio follows standard industry practices for computing and allocating UFE. Our policy and procedures for applying UFE, as well as historical hourly UFE factors, are posted on the AEP Ohio website at:  
<https://www.aepohio.com/account/service/choice/cres/CalculationsProcesses.aspx>.

## Chapter 8 – Billing

### 8.1 Bill Methods

AEP Ohio supports Dual, Consolidated Bill-Ready, and Consolidated Rate-Ready bill methods. These bill methods are defined as follows:

- Dual - The customer receives two bills, one from AEP Ohio for utility charges and one from the CRES Provider for supply charges.
- Consolidated Bill Ready - AEP Ohio accepts bill-ready data calculated by the CRES Provider to be presented on the customer's AEP Ohio bill.
- Consolidated Rate Ready - AEP Ohio calculates and presents CRES charges based on the rates the CRES Provider had previously entered in our Business Partner Portal (BPP).

The EDI 867 transaction is used to transmit usage information as captured from the meter, including interval data recorders (IDR) required for billing. The EDI 867 will be sent in all cases for billing and will contain usage data when AEP Ohio is reading the meter.

The EDI 810 transaction is used to transmit the charges to be presented on the customer's bill. The 810 is not necessary for Dual billing.

When a customer receives a final bill or a final meter reading, the EDI 810 and/or EDI 867 will indicate "final."

The principal billing elements are embodied in the following processes:

- Gathering or retrieval of meter usage data
- Application of tariffs/rates against the data to calculate charges for AEP Ohio charges only
- Receipt of the energy charges that are to be presented to the customer by AEP Ohio on behalf of the CRES Provider
- Presentation of the charges to the customer

### 8.2 Dual Billing



In a Dual billing scenario, the CRES Provider will receive usage data via the EDI 867 transaction from AEP Ohio. In turn, each party will calculate its own charges. AEP Ohio and the CRES Provider will then present its own charges to the customer. Each, in turn, will be responsible for collecting payment for their services from the customer. This option will not display CRES charges on the customer's AEP Ohio bill. The CRES Provider will submit billing to the customer in this scenario. See Diagram 1.

### Dual Billing (Diagram 1)

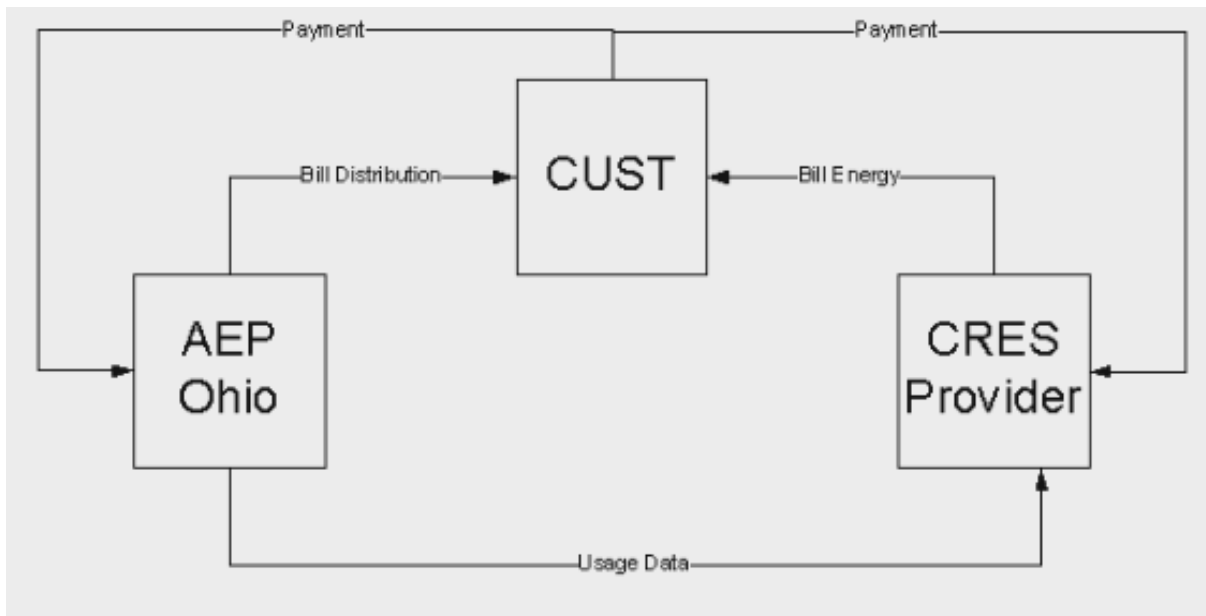

### 8.3 AEP Ohio Consolidated Bill Ready

In this scenario, the CRES Provider will receive usage data via the EDI 867 transaction. In turn, AEP Ohio and the CRES Provider will each calculate its own charges. The CRES Provider will send its calculated Bill-Ready data to AEP Ohio to place on the customer's bill.

The CRES Provider will deliver Bill-Ready data to AEP Ohio for consolidated billing within three business days of receiving the usage (meter reading) data. The 867 EDI transaction contains a Document Due Date segment which provides the date and time

the 810 transaction must be received at AEP Ohio. The EDI transaction business day ends at 5:00 p.m. Eastern Prevailing Time.

Should AEP Ohio receive an 810 outside of the bill window (OBW), AEP Ohio will return an EDI 824 EV (Evaluate). In this case, the 824 is informational only, not a reject of the 810. The 810 does not need to be re-sent. AEP will continue holding any OBW 810s until the next open bill window, and CRES charges will be presented on the customer's next bill.

An example of an 824 EV Outside Bill Window is shown below:

```
ST*824*0002
BGN*11*OPCO6610605B503240470*20170224*****EV
N1*8S*OHIO POWER COMPANY*1*002899953**41
PER*IC*OHIO CHOICE OPERATION*TE*1-614-XXX-XXXX*TE*1-614-XXX-XXXX
N1*SJ*Supplier *1*079334523**40
N1*8R*ASJ., INC.
REF*Q5*001400607xxxxxxxxx
OTI*TR*TN*0005418161*****810
REF*6O*075600190520161220180919090206
TED*848*OBW
NTE*ADD*CHARGE NOT REJECTED - BUT OUTSIDE BILL WINDOW
SE*12*0002
```

AEP Ohio will present the bill to our mutual customer. In addition, AEP Ohio will be responsible for receiving payments from the customer and forwarding payments to the CRES Provider. After a customer pays AEP Ohio, AEP Ohio will transfer payment electronically via an EDI 820 file within 3-4 banking business days to the bank account specified by the CRES Provider, as well as transmit an EDI 820 transaction (with detail account level information) to the CRES's EDI vendor. See Diagram 2 below.

## **AEP Ohio Consolidated Bill-Ready (Diagram 2)**

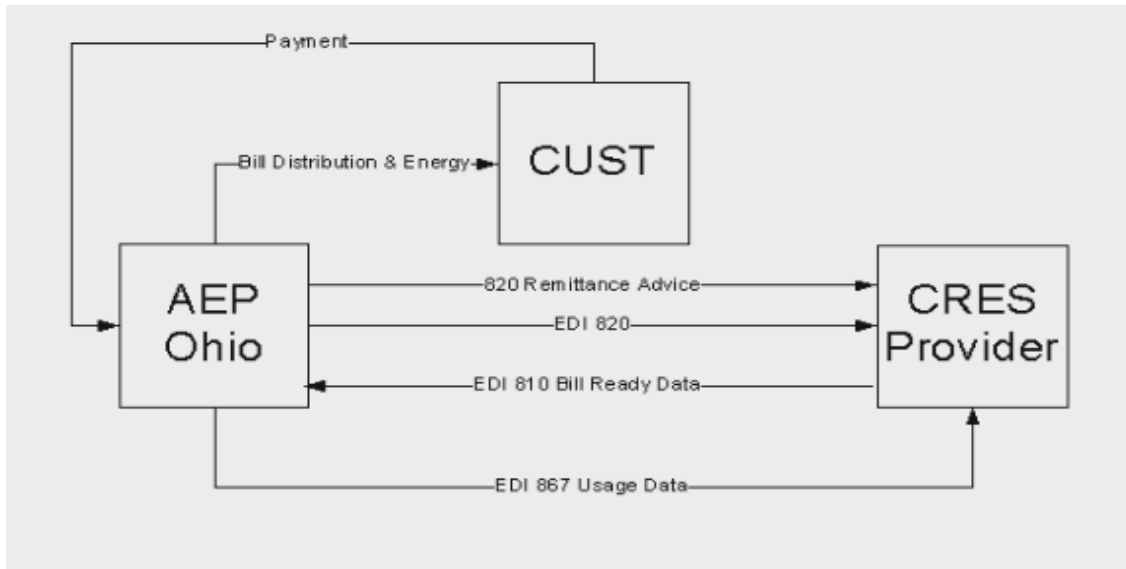

#### 8.4 AEP Ohio Consolidated Rate-Ready

In this scenario, the CRES Provider will enter rates in the BPP. For further information and instructions, please see Rate Ready Frequently Asked Questions found on our website at <https://www.aepohio.com/company/about/choice/cres/rate-ready>.

Based on the CRES Provider’s previously-entered rates, AEP Ohio will calculate the CRES Provider’s charge and present it on the AEP Ohio customer bill. AEP Ohio will send both an 867 usage transaction and an 810 invoice transaction to the CRES Provider.

AEP Ohio will present the bill to our mutual customer. In addition, AEP Ohio will be responsible for receiving payments from the customer and forwarding payments to the CRES Provider. After a customer pays AEP Ohio, AEP Ohio will transfer payment electronically via an EDI 820 file within 3-4 banking business days to the bank account specified by the CRES Provider, as well as transmit an EDI 820 transaction (with detail account level information) to the CRES’s EDI vendor. See Diagram 3 below.

#### AEP Ohio Consolidated Rate-Ready (Diagram 3)

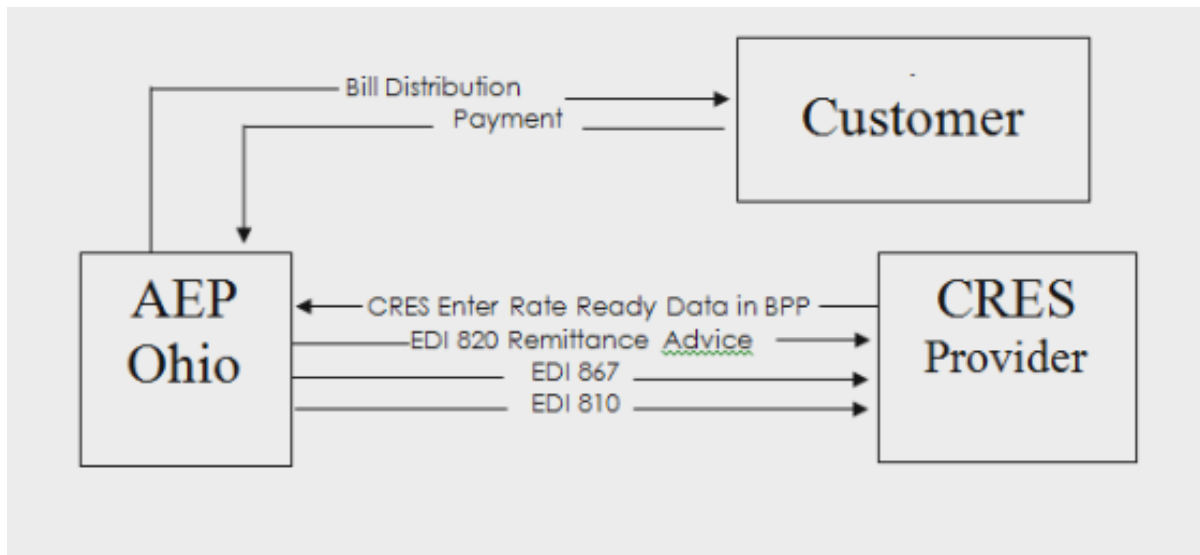

## 8.5 Change Requests

To change a bill method or rate code, the CRES Provider must submit an 814C (Change Request) more than six (6) calendar days prior to the next scheduled read date. If the 814C is received too late, it will be rejected and will have to be re-submitted at the appropriate time. It will not be held in our system.

The effective date of the change will be the last billed date plus one (1).

Example: For an account with a meter read date of 8/30, if the CRES Provider submits an 814C on 8/16 to change a customer from Bill Ready to Rate Ready, this is at least 6 days prior to the 8/30 read date so the 8/30 bill will reflect the 7/30-8/30 service period and will be Rate Ready.

## 8.6 Write-Offs

AEP Ohio will send an EDI 248 Write-off transaction to notify the CRES Provider when the company will no longer attempt to collect payment on behalf of the CRES Provider for Consolidated Bill-Ready and Rate-Ready billed accounts.

After a CRES Provider has received or initiated a drop (by customer requestor by enrolling with another CRES Provider), AEP Ohio will continue to collect and forward

payments to the CRES Provider for one billing cycle(approximately 30 day) from the liability end date. However, if the drop is due to the account being closed,the EDI 248 write-off is sent 35 days after the final bill is issued (which date is identified on the 814D transaction).

AEP Ohio will continue to accept CRES Provider charges or adjustments on an EDI 810 invoice transaction until the write-off date. If an adjustment is received prior to the scheduled write-off date, the write-off date will re-set and occur two days after the new due date. 810 invoice transactions will not be accepted after the write-off date.

If there is a change in usage after the write-off date, AEP Ohio will send corrected usage as a cancel/rebill to the CRES Provider via an EDI 867 transaction. AEP Ohio will not automatically cancel the CRES Provider’s original charge and will not accept an 810 to re-bill for the CRES Provider. The purpose of the 867 transaction is to alert the CRES provider in case the billed usage changes for a period that may need to be rebilled by the CRES provider. AEP will not auto-cancel any CRES Provider’s 810 transactions in these instances.

AEP does not include negative transactions (chargebacks) on the 820 for adjustments done after the write-off/FRED for service periods prior to the expired liability.

The amount written off will appear on the customer’s AEP Ohio bill as “Transfer to Previous Provider to Collect” shown below:

**Line Item Charges:**

Previous Charges	
Total Amount Due At Last Billing	\$ 25,597.58
Payment 07/17/18 - Thank You	-25,597.58
Transfer To Previous Provider To Collect	-12,720.56
<b>Previous Balance Due</b>	<b>\$ -12,720.56*</b>

The write-off date will appear on the customer’s AEP Ohio bill in the bill message section under Notes from AEP Ohio: As of “*date*”, AEP will no longer remit payments to “*CRES Provider*” for “*Account*”.

AEP Write-Off revision pursuant to PUCO Case No. 18-1629-EL-ATA, January 3, 2019.

### Examples of Write-Offs

**Normal active account** - The normal process of a switch from one CRES Provider to another with the Write-Off process of one billing cycle.

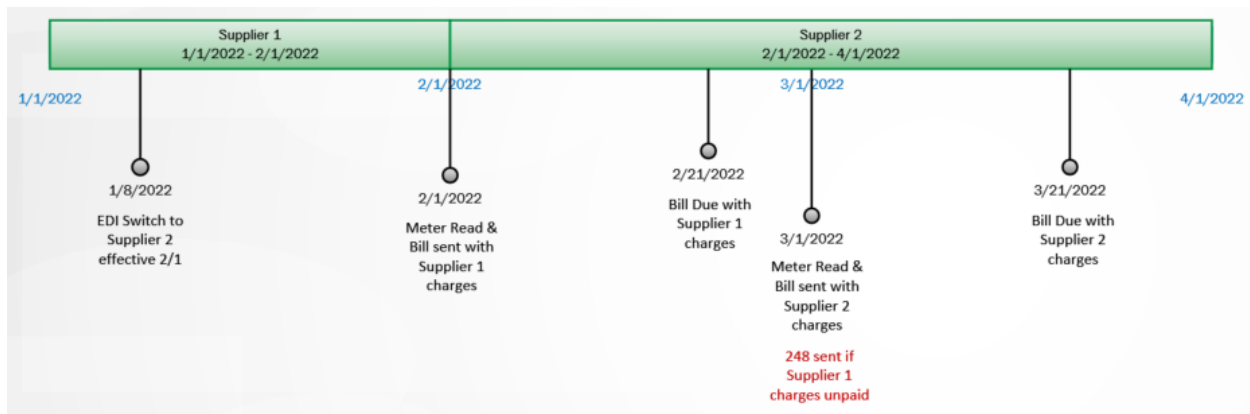

**Cancel/Rebill of Supplier 1** - In the example below, a cancel/rebill is performed after the February bill due date but approximately a week before the March bill date; the February bill will be reissued with adjustments. If the supplier charges are not paid, the write-off will occur two days after the March rebill due date. (If the cancel/rebill occurs

within that week prior to the March bill, the February adjustment will be added to the March bill.)

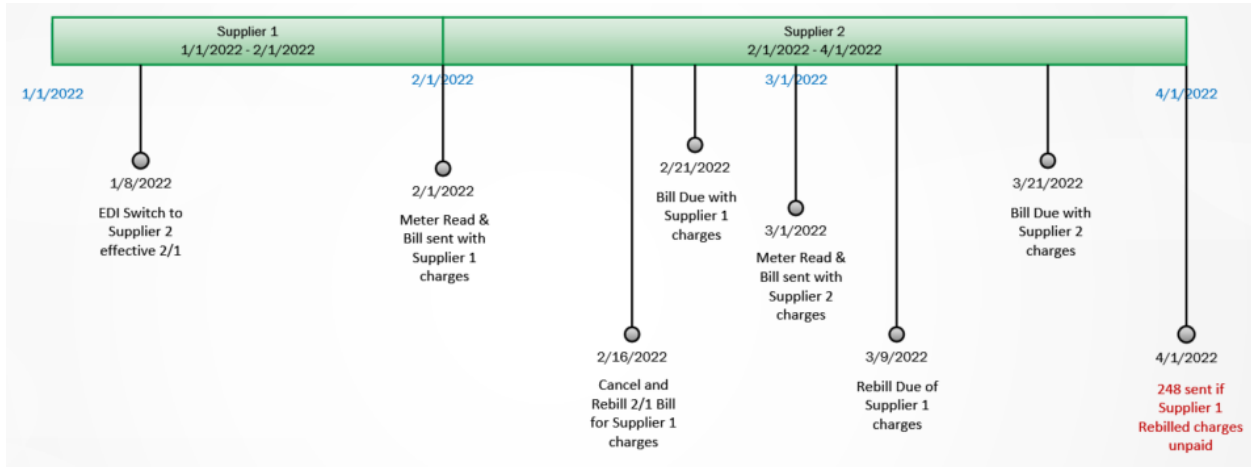

**Final account** - FRED is thirty-five (35) days after the final bill.

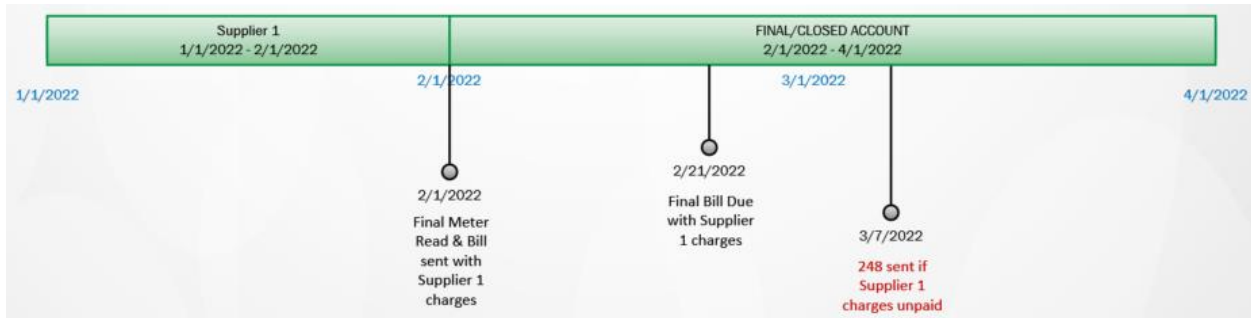

## 8.7 Payment Agreements

Residential customers who are past due can make an agreement with AEP Ohio to pay past-due amounts in installments plus the current monthly bill. The payment agreement total will include CRES Provider charges for active customers. Payment agreement options can be found at [AEPOhio.com](http://AEPOhio.com).

If a customer is making the agreed-upon payments on time, he is considered current in our system even though the customer may be showing past due on the CRES

Provider's books. We adhere to the payment posting hierarchy outlined in Section 8.8 when forwarding payments to CRES Providers.

A CRES Provider drop will cause any payment agreement for CRES charges to be terminated immediately. At that point, the past-due CRES balance becomes due in full and is presented on the next bill that generates.

## **8.8 Payment Processing**

A consolidated-billed customer's payment to AEP Ohio is applied in the following order, as approved by the PUCO:

1. Billed and past-due CRES Provider charges and, if applicable, past-due CRES payment agreement.
2. Billed and past due utility charges and, if applicable, past-due payment agreement.
3. Billed and due current utility charges.
4. Billed and due current CRES Provider charges.
5. Other past due and current non-regulated charges, excluding CRES Provider generation charges.

If there is a disconnect notice, payments will satisfy all CRES and AEP Ohio charges included on the notice in accordance with the above payment posting hierarchy before applying to the remainder of any past due charges that were not included on the notice. Payment for these remaining charges will post in the order as shown above.

After a customer pays AEP Ohio, AEP Ohio will transfer payment(s) electronically within 3-4 banking business days to the bank account specified by the CRES Provider. AEP Ohio will also transmit an EDI 820 transaction (with detail account level information) to the CRES Provider's EDI vendor.

## **8.9 Bill Due Dates**



For the AEP Ohio Consolidated Billing Option, the CRES Provider must adopt the same bill due date as assigned by AEP Ohio. The list of meter reading dates is available on the AEP Ohio website at: <https://www.aepohio.com/company/about/choice/cres/meter-schedules>.

Please note: The meter may be read 1 business day before or 1-2 business days after the scheduled meter read date.

AEP Ohio's standard for due dates is as follows:

- Residential – 21 days
- General Service - 21 days
- Government account - can be up to 30 days (these accounts usually have specified due dates within contracts/agreements)
- Due dates never fall on weekends or on AEP Scheduled holidays.
- All checkless pay customer payments are automatically withdrawn from the customer's bank account on the due date.

## **8.10 CRES Provider Dispute Resolution**

The procedures set forth by the PUCO shall apply to address complaints or disputes. These procedures can be found at <http://www.puco.ohio.gov/>

## **8.11 Dispute Resolution Procedure**

If AEP Ohio and the CRES Provider are unable to resolve a dispute under the dispute resolution procedure, either party may file a formal complaint with the PUCO for resolution. This dispute resolution procedure shall not be interpreted to limit the right of any party to file an appropriate complaint or request for relief with a regulatory authority of competent jurisdiction under any relevant provisions of applicable state or federal law.

## **8.12 AEP Ohio Leveled Payment Options**

AEP Ohio offers customers Leveled Payment Options for utility charges only. These options, Average Monthly Payment Plan or Budget Billing Plan, are outlined on our

website at:

[https://www.aepohio.com/lib/docs/global/CustomerHandbooks/AEP\\_Ohio\\_Handbook.pdf](https://www.aepohio.com/lib/docs/global/CustomerHandbooks/AEP_Ohio_Handbook.pdf)

Customers seeking to enroll in a Leveled Payment option must do so by contacting AEP Ohio at the phone number provided on the customer's bill.

If a CRES Provider wants to offer a CRES leveled plan for generation charges for an AEP Ohio consolidated billed customer, AEP Ohio will not keep records or provide an account balance for a CRES Provider's leveled plan. The CRES Provider must indicate the amount to be billed on the 810 for the duration of the arrangement as a bill message, and show account balance details to inform the customer. See AEP Consolidated Billing Addendum for additional details or contact [ohiochoiceoperation@aep.com](mailto:ohiochoiceoperation@aep.com).

### **8.13 Disconnection of Service for Non-Payment**

AEP Ohio may elect to disconnect service for nonpayment of its charges according to the regulations set forth by the PUCO and as set forth in the Terms and Conditions of Open Access Distribution Services. AEP Ohio cannot disconnect for non-payment of CRES Provider or non-tariff charges per PUCO rules.

### **8.14 Billing for AEP Ohio Services**

Terms for the provision of AEP Ohio services to a CRES Provider, such as consolidated billing, will be included in the service agreement and the billing addendum between AEP Ohio and each CRES Provider.

### **8.15 Billing Agent Registration**

Please refer to Chapter 3 of this handbook for AEP Ohio registration procedures. Details regarding the requirements for certification of a billing agent will be determined by the PUCO when billing agent services become competitive. Also see Supplier

Terms and Conditions in the tariff schedule for AEP Ohio or on our website at <https://www.aepohio.com/account/bills/rates/AEPOhioRatesTariffsOH.aspx>.

### **8.16 Bill Messages on AEP Ohio Bill**

The CRES Provider understands and agrees that it will not send to AEP Ohio via the EDI 810 transaction any CRES Provider marketing message of any type to present on a customer's AEP Ohio consolidated bill

If the inclusion of CRES Provider bill messages requires an additional billing page, the CRES Provider may be charged for the incremental costs incurred to produce and deliver the bill.

The number of CRES Provider bill messages per monthly bill will be limited to six lines with a length of 80 characters each on EDI 810 transactions for Bill Ready customers. The number of CRES Provider bill messages per monthly bill will be limited to three lines with a length of 80 characters each in EDI 814C transactions for Rate Ready customers. These messages will be transmitted to AEP Ohio in accordance with Ohio EDI Working Group (OEWG) standards found at:

<https://puco.ohio.gov/utilities/electricity/resources/electronic-data-interchange>.

### **8.17 Bill Formats**

Examples of different bill formats are listed below. Sample 1 bill is for those customers who receive an AEP Ohio Standard Service Offer bill. Sample 2 bill identifies CRES Provider charges on consolidated billing including the CRES Provider name and phone number. All billings will include customer service phone number (both AEP Ohio and CRES provider, when applicable), Service Delivery Identifier (SDI) number, usage information, and bill messages.

Please note that the SDI can be found under the "Current AEP Ohio Charges" section of the bill directly below the tariff number and description.

In the case of multiple SDI's for one customer account, all SDI's will be listed individually along with all charges relating to that SDI number. All AEP Ohio charges as well as CRES charges will be grouped with the appropriate SDI.

Please read the callouts shown on the left side of the bill for more detailed descriptions of the billing format.

# Sample 1 – AEP Ohio Standard Service

**Amount Due and Due Date**

  
 PO BOX 24401  
 CANTON, OH 44701-4401

Amount due on or before **\$68.57**  
 December 6, 2017  
 Bill mailing date is Nov 20, 2017  
 Account # [REDACTED]

**Customer Mailing Address**

SERVICE ADDRESS: [REDACTED]  
 13259-1 45775  
 070013259 01 AV 0.37

[REDACTED]

**Notes from AEP Ohio:**  
 Make this the last bill sent in the mail. Gain more security and trust and go paperless to get an email notification when your bill is ready. Today is the day! AEPPaperless.com.

**Usage History 12 month summary**

**Current bill summary:**  
 Billing from 10/20/17 - 11/17/17 (29 days)

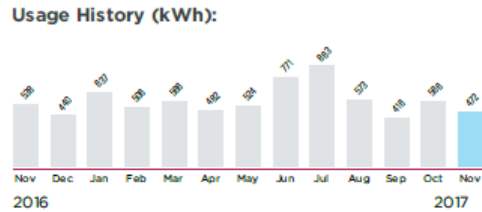

**Customer Charge Ratio Generation (supply) charge, delivery charge, and current usage**

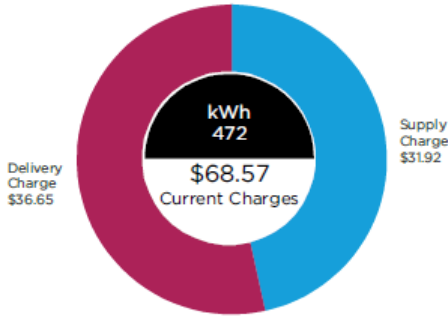

**Methods of Payment**

-  aepohio.com
-  PO Box 24404  
Canton OH 44701-4404
-  1-800-611-0964 (\$2.95 fee)

**Need to get in touch?**  
 Customer Operations Center: 1-800-672-2231  
 View outage information at aepohio.com

**Bill Stub To be returned to AEP Ohio with payment**

**Return Address and Inquiries**

  
 Send Inquiries To:  
 PO BOX 24401  
 CANTON, OH 44701-4401

**Remittance Address**

Make check payable and send to:  
 AMERICAN ELECTRIC POWER  
 PO BOX 24404  
 CANTON OH 44701-4404

[REDACTED]

Account # [REDACTED] 6857  
 Amount due on or before **\$68.57**  
 December 6, 2017

Payment Amount \$

The Neighbor to Neighbor program helps disadvantaged customers pay their electric bill. I want to help. My payment reflects my gift of \$ \_\_\_\_\_

0000068570000685701000000000 [REDACTED] 20110612018900009

**Message Center**

Specific customer related information and company messages including Price-to-Compare

**Customer Information**  
Name and service Address



Service Address:



Account # [Redacted]

**Notes from AEP Ohio:**

**Price-to-Compare:** For tariff 015, in order for you to save money off of your utility's supply charges, a supplier must offer you a price lower than AEP Ohio's price of **\$0.059** per kWh for the same usage that appears on this bill. To review available competitive supplier offers, visit the Public Utilities Commission of Ohio's "Energy Choice Ohio" web site at [www.energychoice.ohio.gov](http://www.energychoice.ohio.gov).

**For Informational Purposes only:** The below costs are NOT NEW CHARGES and are approximate values. AEP participates in programs required by the state of Ohio to support energy conservation and to secure renewable energy resources. For more information on energy efficiency programs, please visit [aepohio.com/ItsYourPower](http://aepohio.com/ItsYourPower).

Renewable Programs: \$0.37  
Energy Efficiency Programs: \$1.17  
Peak Demand Reduction Programs: \$0.44

Due date does not apply to previous balance due.

Register for online services at [www.AEPOhio.com](http://www.AEPOhio.com). Registration is **free and easy** and gives you the convenience of 24-hour access to your account. You can sign up for paperless billing, view your bill, check your usage, update your contact information, and much more.

**Pay online for free when you sign up for paperless billing.** Go to [www.AEPPaperless.com](http://www.AEPPaperless.com) to enroll today!

**Bill Detail**

Previous charges and any activity on account since last statement. Current charge associated with the production, transmission, and delivery of electricity

**Line Item Charges:**

<b>Previous Charges</b>	
Total Amount Due At Last Billing	\$ 193.99
Payment 11/13/17 - Thank You	-193.99
<b>Previous Balance Due</b>	<b>\$ .00*</b>
<b>Current AEP Ohio Charges</b>	
<b>Tariff 015 - Residential Service 11/17/17</b>	
Service Delivery Identifier: [Redacted]	
Generation Service	\$ 27.66
Transmission Service	8.13
Distribution Service	18.79
Customer Charge	8.40
Retail Stability Rider	.73
Deferred Asset Phase-In Rider	1.33
Phase-In Recovery Rider	2.62
Power Purchase Agreement Rider	.91
<b>Current Electric Charges</b>	<b>\$ 68.57*</b>
<b>Total Balance Due</b>	<b>\$ 68.57</b>
*Charges make up the "Total Balance Due"	

**Usage Details:**

↑Values reflect changes between current month and previous month.

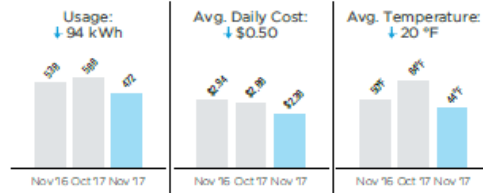

Total usage for the past 12 months: 6,882 kWh

Average (Avg.) monthly usage: 574 kWh

**Meter Read Details:**

Meter # [Redacted]					
Previous	Type	Current	Type	Metered	Usage
46237	Actual	46709	Actual	472	472 kWh
Service Period 10/19 - 11/17				Multiplier 1	
Next scheduled read date should be between Dec 20 and Dec 27.					

**Usage Details**

Comparison between current and previous months (usage, avg. cost, avg. temperature)

**Usage Table**

Includes current and previous meter readings, kWh used in current period, and next scheduled read date. Type represents meter activity and actual/estimated reading.

# Sample 2 – AEP Ohio Open Access Distribution

**Amount Due and Due Date**

  
 PO BOX 24401  
 CANTON, OH 44701-4401

Amount due on or before December 6, 2017 **\$84.68**  
 Bill mailing date is Nov 20, 2017  
 Account # [REDACTED]

**Customer Mailing Address**

SERVICE ADDRESS: [REDACTED]  
 20124-1 18315  
 070020124 01 AV 0.37

[REDACTED]

**Notes from AEP Ohio:**

**Make this the last bill sent in the mail.** Gain more security and trust and go paperless to get an email notification when your bill is ready. Today is the day! AEPPaperless.com.

**Usage History (kWh):**

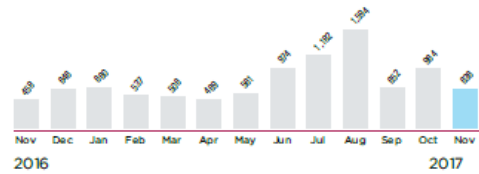



**Usage History 12 month summary**

**Current bill summary:**  
Billing from 10/21/17 - 11/20/17 (31 days)

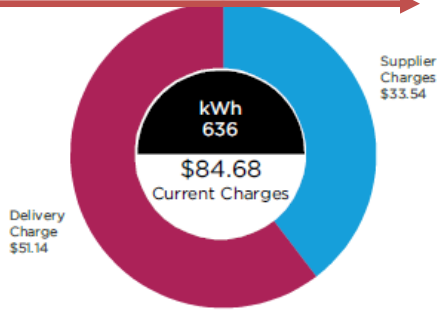
**Customer Charge Ratio**  
Generation (supply) charge, Delivery charge, and current usage



**Methods of Payment**

-  aepohio.com
-  PO Box 24404  
Canton OH 44701-4404
-  1-800-611-0964 (\$2.95 fee)

**Need to get in touch?**

Customer Operations Center: 1-800-672-2231  
View outage information at aepohio.com

Turn over for important information! ➔

Thank you for your prompt payment. Please include your account number on your check and return this stub with your payment.

[REDACTED]

**Bill Stub To be returned to AEP Ohio with payment**

**Return Address and Inquiries**

  
 Send Inquiries To:  
 PO BOX 24401  
 CANTON, OH 44701-4401

**Remittance Address**

Make check payable and send to:  
 AMERICAN ELECTRIC POWER  
 PO BOX 24404  
 CANTON OH 44701-4404

[REDACTED]

Account # [REDACTED] 5114

Amount due on or before December 6, 2017 **\$84.68**

Payment Amount \$ [REDACTED]

The Neighbor to Neighbor program helps disadvantaged customers pay their electric bill. I want to help. My payment reflects my gift of \$ \_\_\_\_\_

00000846800000846801000000000 [REDACTED] 20110612016900005

**Usage Details**

Comparison between current and previous months (usage, avg. cost, avg. temperature)

**Customer Information**

Name and service Address

**Bill Detail**

Previous charges and any activity on account since last statement. Current charge associated with the production, transmission, and delivery of electricity. AEP Ohio no longer bills Generation.

**Supplier Info**

Contact, logo, rate per kWh, and generation related charges

**Message Center**

Specific customer related information and company messages including Price-to-Compare

**Usage Table**

Includes current and previous meter readings, kWh used in current period, and next scheduled read date. Type represents meter activity and actual/estimated reading.



**Service Address:**

Service Address: [Redacted]  
Account #: [Redacted]

**Line Item Charges:**

Previous Charges	
Total Amount Due At Last Billing	\$ 122.69
Payment 11/07/17 - Thank You	-122.69
<b>Previous Balance Due</b>	<b>\$ .00*</b>
Current AEP Ohio Charges	
Tariff 820 - Residential Service 11/20/17	
Service Delivery Identifier: [Redacted]	
Transmission Service	\$ 10.95
Distribution Service	24.49
Customer Charge	8.40
Retail Stability Rider	.98
Deferred Asset Phase-In Rider	1.56
Phase-In Recovery Rider	3.53
Power Purchase Agreement Rider	1.23
<b>Current Electric Charges</b>	<b>\$ 51.14*</b>

<SUPPLIER LOGO>

Current Supplier Name Charges (999-999-9999)	
Supplier Account Number - [Redacted]	
Service Delivery Identifier: [Redacted] 11/20/17	
Description of Supplier Charges	\$ 33.54
<b>Current Supplier Balance Due</b>	<b>\$ 33.54*</b>
<b>Total Balance Due</b> \$ 84.68	
*Charges make up the "Total Balance Due"	

**Usage Details:**

↑↓ Values reflect changes between current month and previous month.

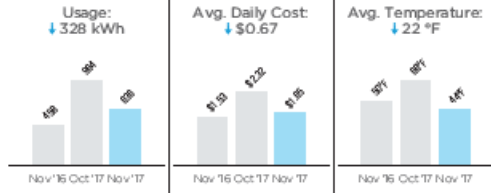

Total usage for the past 12 months: 9,203 kWh  
Average (Avg.) monthly usage: 767 kWh

**Meter Read Details:**

Meter # [Redacted]					
Previous	Type	Current	Type	Metered	Usage
7717	Actual	8353	Actual	636	636 kWh
Service Period 10/20 - 11/20				Multiplier 1	
Next scheduled read date should be between Dec 18 and Dec 21.					

**Notes from AEP Ohio:**

**Price-to-Compare:** For tariff 820, in order for you to save money off of your utility's supply charges, a supplier must offer you a price lower than AEP Ohio's price of \$0.059 per kWh for the same usage that appears on this bill. To review available competitive supplier offers, visit the Public Utilities Commission of Ohio's "Energy Choice Ohio" web site at [www.energychoice.ohio.gov](http://www.energychoice.ohio.gov).

**For Informational Purposes only:** The below costs are NOT NEW CHARGES and are approximate values. AEP participates in programs required by the state of Ohio to support energy conservation and to secure renewable energy resources. For more information on energy efficiency programs, please visit [aepohio.com/ItsYourPower](http://aepohio.com/ItsYourPower).

- Renewable Programs: \$0.50
- Energy Efficiency Programs: \$1.57
- Peak Demand Reduction Programs: \$0.59

As a participant in the AEP Ohio Customer Choice Program, your electric energy is being supplied by Supplier Name. This bill reflects AEP Ohio charges for delivery of the electric and all electric energy supply charges AEP Ohio has received from your supplier as of the Billing Date shown on this bill. For questions about your electric energy supply charges please contact Supplier Name at (999)999-9999. Please note that failure to pay charges for competitive retail electric services (CRES) may result in loss of those products and services, the cancellation of your contract with the CRES provider and your return to AEP Ohio's Standard Offer for energy supply services.

Due date does not apply to previous balance due.

Register for online services at [www.AEPOhio.com](http://www.AEPOhio.com). Registration is free and easy and gives you the convenience of 24-hour access to your account. You can sign up for paperless billing, view your bill, check your usage, update your contact information, and much more.

**Worried that changes in the postal service may delay your bill or your payment?** Go paperless! You'll receive an email notification when your new bill is available for viewing. You'll also be able to pay online for free. Go to [www.AEPPaperless.com](http://www.AEPPaperless.com) to enroll today!



## Chapter 9 – Metering

### 9.1 Meter Service Provider (MSP) Registration

Please contact [cresregistration@aep.com](mailto:cresregistration@aep.com) concerning AEP Ohio's Meter Service Provider (MSP) registration requirements, and see the Supplier Terms and Conditions in the OAD tariff schedule at <https://www.aepohio.com/company/about/rates>.

### 9.2 Guidelines for Meter Installation

- 1) All customers with peak monthly demands of 200 kW or greater in the past 12-month period who choose a CRES Provider must have interval metering. The customer will be billed for the cost of the interval metering on the next monthly bill following installation of the meter. Customers located within an AMI meter area are exempt from this requirement.
- 2) Customers that operate generation in parallel with the utility system (on-line synchronous operation, but not emergency stand-by) must provide AEP Ohio with access to hourly interval output measurements from meters/recorders meeting the requirements for accuracy and remote access.
- 3) All interval meters must meet ANSI C12.1 standards and any statewide standards established in the future.
- 4) All CRES providers, MSPs and Meter Data Management Agents (MDMA) shall comply with the Supplier Terms and Conditions of Service in AEP Ohio's Open Access Distribution Tariff.
- 5) The CRES Provider should request meter upgrades or exchanges prior to the customer's enrollment in the customer choice program.

### 9.3 Meter Ownership Options

#### AEP Ohio Acting as the MSP and MDMA

All metering and billing services will be provided by AEP Ohio whenever the customer takes the company's Standard Service Offer.

- AEP Ohio will install all necessary interval metering.
- The customer will be responsible for the costs associated with the installation of the interval metering.

- AEP Ohio will select the meter type used for all new and replacement installations.  
<https://www.aepohio.com/account/service/choice/cres/MeteringUsage.aspx>

#### **9.4 Meter Testing and Maintenance**

Please refer to the Meter Accuracy and Test Provisions of the AEP Ohio Terms and Conditions of Service.

#### **9.5 Meter Calibrations**

This information is provided upon request by sending an email to:  
[ohiochoiceoperation@aep.com](mailto:ohiochoiceoperation@aep.com).

#### **9.6 Meter Costs**

Meter charges for installation of interval metering by AEP Ohio will be the incremental difference between a customer's existing meter and the new interval meter including labor expenses. Please refer to:

<https://www.aepohio.com/account/service/choice/cres/MeteringUsage.aspx>

#### **9.7 Meter Investigation Orders**

CRES Provider or customer-initiated investigation orders will be received by the AEP Ohio Hurricane Solution Center (1-888-237-5566). The company's Meter Services group will investigate upon receipt of the order and will provide notification of the result. Additional fees, per visit, will be charged for the following:

- Investigation into the loss of external communications via cellular or AMI internal radios
- Manual retrieval of interval data

#### **9.8 Standard Meter Specifications**

The standard residential meter is a single phase Aclara I210c and I210+c. The standard commercial meter is an Aclara polyphase model KV2c, which comes in both self-contained and transformer rated versions.

## **9.9 Combination Meter Specifications**

The standard combination meter is a single phase Aclara I210+c . The standard combination commercial meter is an Aclara polyphase model KV2c, which comes in both self-contained and transformer rated versions. The meters must be programmed with the proper block demand interval.

## **9.10 Time of Use Meter Specifications**

The standard time of use meter is a single phase Aclara I210+c. The standard time of use commercial meter is an Aclara polyphase model KV2c, which comes in both self-contained and transformer rated versions. The meters must be programmed with the proper time of use schedule along with the agreed upon holiday schedule and appropriate software switches.

## **9.11 Interval Metering Specifications**

The standard interval meter can be either a single phase Aclara I210+c or an Aclara polyphase model KV2c. The Aclara polyphase model KV2c comes in both self-contained and transformer rated versions. The meters must be programmed with the proper interval length, reactive channel, remote interrogation and all appropriate software switches. In addition, the software switch must be added to all non AMI meters. AMI meters have load profile soft switches added at the time of manufacture.

Interval metering installed must:

- Be compatible for remote interrogation with MV-90 vsn. 6.2 or greater.
- Be programmed to meet the lower required interval of either the CRES Provider or AEP Ohio.
- Be programmed to record each needed channel of data to meet the billing determinant requirements for both the CRES Provider and AEP Ohio.
- Be compatible for remote interrogation.

- Be equipped to record during power outages of less than four hours per day and a total of 10 hours of outage per month.
- Have a data magnitude accuracy of 98 percent or greater.
- Have a time accuracy of 99 percent or greater.
  
- Have Opticom port capability in the absence of remote interrogation (Note: A fee may be charged for these manual reads).
- Be capable of storing at least 40 days of interval data.
- Be easily repaired or replaced.

### **9.12 Abnormal Conditions**

MSPs shall report to AEP Ohio any abnormal conditions at the customer's site including equipment malfunction, theft, etc.

# Chapter 10 – Meter Data Management

## 10.1 Meter Data Management Agent Registration

Please contact [cresregistration@aep.com](mailto:cresregistration@aep.com) concerning AEP Ohio's Meter Data Management Agent (MDMA) registration requirements, and see the Supplier Terms and Conditions in the OAD tariff schedule at <https://www.aepohio.com/company/about/rates>.

## 10.2 Meter Reading Schedules

Current meter reading schedules may be obtained at:

[Meter Reading Schedule & Codes \(aepohio.com\)](#)

**Note:** The meter may be read 1 business day before or 1-2 business days after the date listed.

## 10.3 Policy for Estimating Usage

When meter readers do not obtain meter readings for regular billings, AEP Ohio may estimate readings subject to the provisions/requirements specified in the Terms and Conditions of Service.

For estimations, the billing software uses the average usage for the previous month and year ago method, the variance factor method or the previous usage a year ago method. Generally the following normal types of load data will not be estimated by the billing system:

- Budget billing accounts on the sixth and twelfth months
- Accounts with three consecutive estimated bills
- Commercial and Industrial customers with space heating
- Certain demand meters (except in emergency situations, such as severe weather. If demand meters are estimated, the first previous demand reading will be used)
- Reactive meters
- Time of Day meters

- Large commercial and industrial accounts

### **Large Power/MV-90 Process:**

AEP Ohio will utilize the following automated validation process supported by the MV-90 system:

#### **Pulses validity comparison**

MV-90 will gather meter readings (actual, emulated or electronic) and apply the appropriate meter multiplier with any associated pulse offset constant which yields meter kWh. Total pulses multiplied by the appropriate pulse constant will yield pulse kWh. MV-90 will conduct a comparison between the meter kWh and pulse kWh. Any differences which exceed one time the meter multiplier will normally be rejected and will require manual review (for some very high pulse rate installations, this “one time” value may be increased as appropriate to insure routine accurate validation).

#### **Interval number validity comparison**

MV-90 will calculate the number of intervals expected based upon the provided start and stop dates/times and the interval/hour for the recorder in question. The expected interval will be compared against the found number of intervals. Any comparisons which do not compare exactly will be rejected and will require manual review.

AEP Ohio will routinely review translations that the MV-90 automatically rejects. Should an extenuating circumstance exist that causes an automatically accepted translation to be suspect, AEP Ohio will conduct the appropriate manual review.

Any translations that require manual review will initiate an investigation. This may include investigation by the measurements group, telecommunications, station/line or the accounting customer services system and/or other groups that provide information. Corrective action required in the field will be initiated as a result of the review.

Based upon the information gained, the particular data problem, and the recommendation of the MV-90 specialist conducting the editing/estimation, appropriate remedial action will be taken. Generally speaking, a few hours of missing or erroneous data will be manually inserted appropriately with focus on the accuracy of the magnitude and time correctness. Standard MV-90 estimation processes will be used to calculate missing or erroneous data greater than a few hours. Where possible, the estimated data will be balanced to a corresponding meter kWh.

### **Estimating**

The AEP Ohio MV-90 specialist will have the discretion to use the appropriate editing/estimation process. One of the options available for estimation is the MV-90 plugging process. This process spreads kWh energy using a model period of data. The MV-90 specialist responsible for the estimation will determine the choice of the model data and the data period.

Another option available in MV-90 is the copy process. The process uses a model data period and can be scaled. The scaling factor will prorate the model period of data to a given kWh. The choice of the model data and data period is at the discretion of the specialist responsible for the estimation.

## **10.4 Telemeter Reading Options**

### **Procedure**

The meter interrogation will follow the current schedule unless otherwise requested by the CRES Provider or customer.

### **Information Transfer**

Meter reading information will be transferred to the CRES Provider on a billing cycle frequency.

## **10.5 Meter Data Retrieval**

Any interval metering installed must be:

- Capable of having data retrieved 24 hours a day, 7 days a week
- Available for hard-wire telephone line remote interrogation at least 90 percent of the time
- Successful at data retrieval for at least 85 percent of the calls made (excludes MV-90 type problems)
- Able to retrieve data via an Opticom port in instances of recorder/phone line problems continue more than five days.

## **10.6 Providing Meter Data**

The MDMA is required to provide data in a timely manner and under secure conditions.

## **10.7 Abnormal Conditions**

MDMAs shall report to AEP Ohio any abnormal conditions at the customer's site including equipment malfunction, theft, etc.



# Chapter 11- Transmission and Related Services

## 11.1 PJM Agreements

Eligible retail consumers and CRES Providers participating in the Ohio Customer Choice program will interact with PJM Interconnection, LLC (PJM), to arrange transmission services and deliver electricity to loads in the AEP Ohio service territory. Visit the PJM website at <http://www.pjm.com/> for information on becoming a member or contact PJM Member Relations toll free at 1-866-400-8980.

Transmission service to transmission customers will be provided in accordance with the terms and conditions of the PJM Open Access Transmission Tariff (OATT) available at <https://agreements.pjm.com/oatt/3897>.

This chapter of the CRES Provider Handbook is not intended as a replacement for the PJM OATT. Transmission customers participating in the program are expected to become familiar with the PJM OATT and all applicable provisions and agreements which can be found at <http://www.pjm.com/documents/agreements.aspx>.

Pursuant to FERC rules, PJM maintains an Open Access Same-Time Information System (OASIS) website that provides comprehensive information for doing business under PJM's OATT. It is recommended that CRES Providers use this site as the definitive source of current OATT provisions and business practices. This site is located at <https://www.pjm.com/markets-and-operations/etools/oasis>.